

Design

CLARON STYLE P is designed with a symmetrical profile for use as a single acting Rod or Piston seal. The seal is a precision moulded Nitrile rubber sealing element with a fabric reinforced base to resist extrusion. Designed with initial radial interference to effect low pressure sealing, at higher pressures the seal is energised thus increasing the sealing force. Rubberised fabric has the advantage of retaining the sealing media within it's surface, so reducing friction and wear. Style CP is an effective seal over a wide range of applications.

Operating Conditions

Maximum Pressure	
Max Speed	Temp. Range
m/s	-30°C to 100°C
0.50	250 Bar
0.15	400 Bar

These range parameters are Maximum simultaneous conditions. Optimum service conditions are affected by temperature, speed, pressure, surface finish and extrusion gaps. Refer to Appendix 1 for further information.

Maximum Diametral Clearance F

Pressure Bar

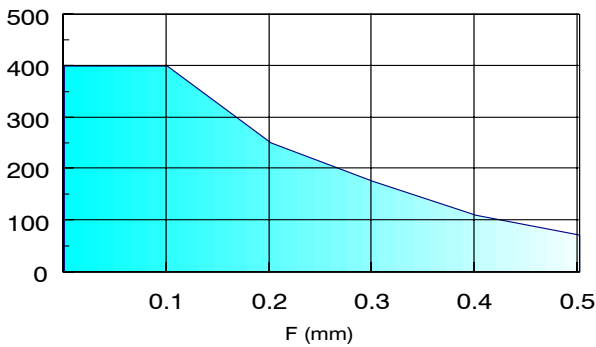

Continuous operating temperature for various Fluids

NBR Rubber		
DIN	Hydraulic Fluid Description	°C
H	Mineral oil without additives	100
H-L	Mineral Fluid with anti corrosion and anti ageing additives	100
H-LP	Mineral oil as HL plus additives reducing wear, raising load	100
H-LPD	Mineral oil as H-LP but with detergents and dispersants	100
H-V	Mineral oil as H-LP plus improved viscosity temp.	100
HFA E	Emulsions of mineral oil in water. Water content 80-95%	55
HFA S	Synthetic oil in water. Water content 80-95%	55
HFB	Emulsions of water in mineral oil. Water content 40%	60
HFC	Aqueous polymer solutions. Water content 35%	60
HFD R	Phosphoric acid ester based	NS
HFD S	Chlorinated hydrocarbon based	NS
HFD T	Mixtures of HFD R and HFD S	NS
HEPG	Polyglycol based	NS
HETG	Vegetable Oil based	60
HEES	Fully synthetic ester based	NS

Note: Clearance gap F is the maximum permissible. i.e. gap completely on one side, in the temperature range of -30°C to 100°C The use of a suitably selected Claron bearing ring will effectively reduce the clearance gap F max. to a value closer to F/2 thus increasing the pressure capability of the seal.

Housing

For surface finish and recommended lead in chamfers refer to the illustration below. For housing dimensions and machining tolerances refer to the catalogue page of selected seal. Refer to Appendix 4 for value of tolerance symbols. For Piston applications refer to section B.

Fitting

For the seal to function correctly, it is important that care be taken in fitting the seal within its housing. For a detailed checklist, refer to Appendix 3.

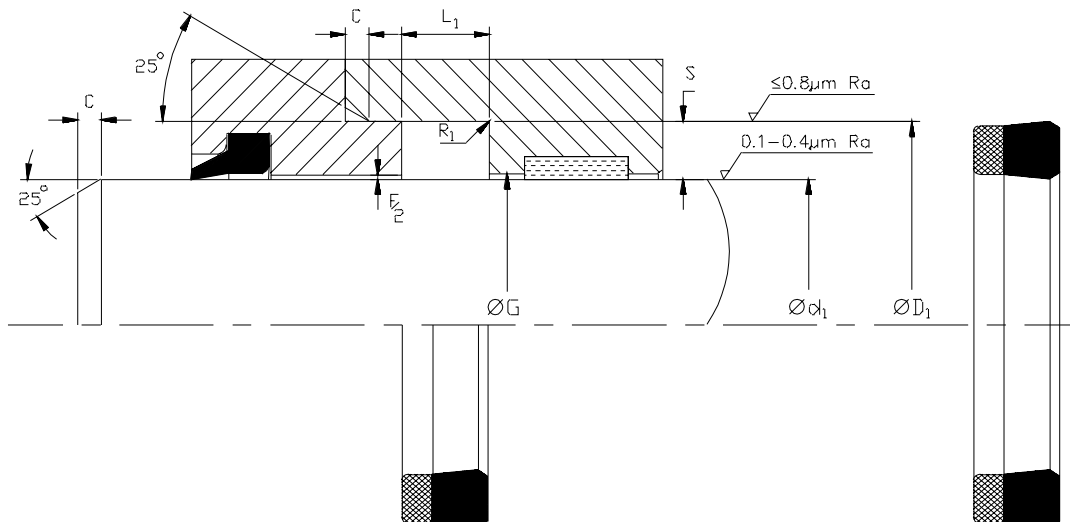



Nominal Dimensions & Machining Tolerances

Claron Part Number	Js11	f8	H9	+0.025 +0.015	Nominal	Min	Max
	ØD ₁	Ød ₁	ØG	L ₁	S	C	R ₁
P 056025	0.562	0.250		0.250	0.156	0.093	0.010
P 062031	0.625	0.312		0.250	0.156	0.093	0.010
P 062037	0.625	0.375		0.187	0.125	0.093	0.010
P 075037	0.750	0.375		0.281	0.187	0.093	0.010
P 075050	0.750	0.500		0.187	0.125	0.093	0.010
P 081043	0.812	0.437		0.281	0.187	0.093	0.010
P 087050	0.875	0.500		0.281	0.187	0.093	0.010
P 087062	0.875	0.625		0.187	0.125	0.093	0.010
P 093056	0.937	0.562		0.281	0.187	0.093	0.010
P 100062	1.000	0.625		0.281	0.187	0.093	0.010
P 100075	1.000	0.750		0.187	0.125	0.093	0.010
P 109075	1.093	0.750		0.281	0.171	0.093	0.010
P 112062	1.125	0.625		0.375	0.250	0.125	0.015
P 112075	1.125	0.750		0.312	0.187	0.093	0.010
P 112087	1.125	0.875		0.163	0.125	0.093	0.010
P 118068	1.187	0.687		0.375	0.250	0.125	0.015
P 125075/1	1.250	0.750		0.312	0.250	0.125	0.015
P 125075/2	1.250	0.750		0.375	0.250	0.125	0.015
P 125087	1.250	0.875		0.375	0.187	0.093	0.010
P 125100	1.250	1.000		0.187	0.125	0.093	0.010
P 125100/1	1.250	1.000		0.121	0.125	0.093	0.010
P 131081	1.312	0.812		0.375	0.250	0.250	0.015
P 137087	1.375	0.875		0.375	0.250	0.125	0.015
P 137087/1	1.375	0.875		0.250	0.250	0.125	0.125
P 137100	1.375	1.000		0.250	0.187	0.093	0.010
P 137112	1.375	1.125		0.187	0.125	0.093	0.010
P 143093	1.437	0.937		0.375	0.250	0.125	0.015
P 150087	1.500	0.875		0.375	0.312	0.156	0.015
P 150098	1.500	0.980		0.380	0.260	0.125	0.015
P 150100	1.500	1.000		0.375	0.250	0.125	0.015
P 150100/1	1.500	1.000		0.250	0.250	0.125	0.015
P 150125	1.500	1.250		0.187	0.125	0.093	0.010
P 156112	1.562	1.125		0.343	0.218	0.125	0.015
P 162100	1.625	1.000		0.437	0.312	0.156	0.015
P 162112	1.625	1.125		0.375	0.250	0.125	0.015
P 162125	1.625	1.250		0.281	0.187	0.093	0.010
P 162125/1	1.625	1.250		0.250	0.187	0.093	0.010
P 162125/2	1.625	1.250		0.500	0.187	0.093	0.010
P 162130	1.627	1.302		0.240	0.162	0.093	0.010
P 168118/1	1.687	1.187		0.375	0.250	0.125	0.015
P 175100	1.750	1.000		0.375	0.375	0.187	0.032
P 175112	1.750	1.125		0.437	0.312	0.156	0.015
P 175123	1.750	1.235		0.340	0.257	0.125	0.015
P 175125	1.750	1.250		0.375	0.250	0.125	0.015
P 175125/1	1.750	1.250		0.281	0.250	0.125	0.015

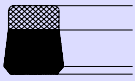

P

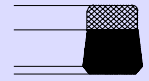

Nominal Dimensions & Machining Tolerances

Claron Part Number	Js11	f8	H9	+0.025 +0.015	Nominal	Min	Max
	ØD ₁	Ød ₁	ØG	L ₁	S	C	R ₁
P 175125/2	1.750	1.250		0.250	0.250	0.125	0.015
P 175137	1.750	1.375		0.281	0.187	0.093	0.010
P 187125	1.875	1.250		0.437	0.312	0.156	0.015
P 187125/1	1.875	1.250		0.312	0.312	0.156	0.015
P 187125/2	1.875	1.250		0.500	0.312	0.156	0.015
P 187125/3	1.875	1.250		0.406	0.312	0.156	0.015
P 187150	1.875	1.500		0.172	0.187	0.093	0.010
P 187150/1	1.875	1.500		0.250	0.187	0.093	0.010
P 193168	1.937	1.687		0.187	0.125	0.093	0.010
P 200137/1	2.000	1.375		0.375	0.312	0.156	0.015
P 200137/2	2.000	1.375		0.437	0.312	0.156	0.015
P 200137/3	2.000	1.375		0.500	0.312	0.156	0.015
P 200137/4	2.000	1.375		0.312	0.312	0.156	0.015
P 200148	2.000	1.485		0.340	0.257	0.125	0.015
P 200150	2.000	1.500		0.375	0.250	0.125	0.015
P 200150/1	2.000	1.500		0.468	0.250	0.125	0.015
P 200150/4	2.000	1.500		0.250	0.250	0.125	0.015
P 200162/2	2.000	1.625		0.276	0.187	0.093	0.010
P 212150/1	2.125	1.500		0.437	0.312	0.156	0.015
P 212150/2	2.125	1.500		0.468	0.312	0.156	0.015
P 212175	2.125	1.750		0.172	0.187	0.093	0.010
P 212175/1	2.125	1.750		0.300	0.187	0.093	0.010
P 212175/2	2.125	1.750		0.281	0.187	0.093	0.010
P 218150	2.187	1.500		0.437	0.343	0.156	0.015
P 225150	2.250	1.500		0.468	0.375	0.187	0.032
P 225162	2.250	1.625		0.437	0.312	0.156	0.015
P 225175/1	2.250	1.750		0.375	0.250	0.125	0.015
P 225175/2	2.250	1.750		0.437	0.250	0.125	0.015
P 225187	2.250	1.875		0.265	0.187	0.093	0.010
P 237175	2.375	1.750		0.437	0.312	0.156	0.015
P 237200	2.375	2.000		0.172	0.187	0.093	0.010
P 243175	2.437	1.750		0.437	0.343	0.156	0.015
P 250175	2.500	1.750		0.500	0.375	0.156	0.015
P 250187	2.500	1.875		0.437	0.312	0.156	0.015
P 250187/1	2.500	1.875		0.375	0.312	0.156	0.015
P 250187/3	2.500	1.875		0.312	0.312	0.156	0.015
P 250198	2.500	1.980		0.360	0.260	0.125	0.015
P 250200	2.500	2.000		0.312	0.250	0.125	0.015
P 250200/1	2.500	2.000		0.375	0.250	0.125	0.015
P 250200/2	2.500	2.000		0.343	0.250	0.125	0.015
P 262187	2.625	1.875		0.625	0.375	0.187	0.032
P 262200	2.625	2.000		0.437	0.312	0.156	0.015
P 262200/2	2.625	2.000		0.312	0.312	0.156	0.015
P 262200/3	2.625	2.000		0.500	0.312	0.156	0.015
P 262212	2.625	2.125		0.375	0.250	0.125	0.015

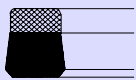

Nominal Dimensions & Machining Tolerances

Claron Part Number	Js11	f8	H9	+0.025 +0.015	Nominal	Min	Max
	ØD ₁	Ød ₁	ØG	L ₁	S	C	R ₁
P 262225	2.625	2.250		0.172	0.187	0.093	0.010
P 262225/1	2.625	2.250		0.210	0.187	0.093	0.010
P 275200	2.750	2.000		0.437	0.375	0.187	0.032
P 275200/1	2.750	2.000		0.625	0.375	0.187	0.032
P 275200/2	2.750	2.000		0.562	0.375	0.187	0.032
P 275212	2.750	2.125		0.375	0.312	0.156	0.015
P 275225	2.750	2.250		0.375	0.250	0.125	0.015
P 275231	2.750	2.312		0.375	0.219	0.093	0.010
P 287200	2.875	2.000		0.625	0.437	0.187	0.032
P 287212	2.875	2.125		0.562	0.375	0.187	0.032
P 287225	2.875	2.250		0.437	0.312	0.156	0.015
P 287237	2.875	2.375		0.281	0.250	0.125	0.015
P 300200	3.000	2.000		0.750	0.500	0.250	0.032
P 300212	3.000	2.125		0.500	0.437	0.187	0.032
P 300225	3.000	2.250		0.375	0.375	0.187	0.032
P 300225/1	3.000	2.250		0.500	0.375	0.187	0.032
P 300225/2	3.000	2.250		0.562	0.375	0.187	0.032
P 300237	3.000	2.375		0.468	0.312	0.156	0.015
P 300250	3.000	2.500		0.312	0.250	0.125	0.015
P 306250	3.062	2.500		0.437	0.281	0.125	0.015
P 312237	3.125	2.375		0.562	0.375	0.187	0.032
P 312250	3.125	2.500		0.625	0.312	0.156	0.015
P 312250/1	3.125	2.500		0.375	0.312	0.156	0.015
P 325250	3.250	2.500		0.375	0.375	0.187	0.032
P 325250/1	3.250	2.500		0.562	0.375	0.187	0.032
P 325250/2	3.250	2.500		0.625	0.375	0.187	0.032
P 325250/3	3.250	2.500		0.468	0.375	0.187	0.032
P 325262	3.250	2.625		0.562	0.312	0.156	0.015
P 325273	3.250	2.735		0.340	0.257	0.125	0.015
P 325275	3.250	2.750		0.375	0.257	0.125	0.015
P 337262	3.375	2.625		0.562	0.375	0.187	0.032
P 337275/1	3.375	2.750		0.437	0.312	0.156	0.015
P 350250	3.500	2.500		0.750	0.500	0.250	0.032
P 350275	3.500	2.750		0.562	0.375	0.187	0.032
P 350275/1	3.500	2.750		0.375	0.375	0.187	0.032
P 350275/3	3.500	2.750		0.500	0.375	0.187	0.032
P 350287	3.500	2.875		0.470	0.312	0.156	0.015
P 350300	3.500	3.000		0.375	0.250	0.125	0.015
P 362262	3.625	2.625		0.750	0.500	0.250	0.032
P 362287	3.625	2.875		0.562	0.375	0.187	0.032
P 362300	3.625	3.000		0.375	0.312	0.156	0.015
P 375275	3.750	2.750		0.500	0.500	0.250	0.032
P 375300	3.750	3.000		0.562	0.375	0.187	0.032
P 375300/1	3.750	3.000		0.500	0.375	0.187	0.032
P 375300/2	3.750	3.000		0.375	0.375	0.187	0.032

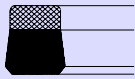

Nominal Dimensions & Machining Tolerances

Claron Part Number	Js11	f8	H9	+0.025 +0.015	Nominal	Min	Max
	ØD ₁	Ød ₁	ØG	L ₁	S	C	R ₁
P 375323	3.750	3.230		0.360	0.260	0.125	0.015
P 387287	3.875	2.875		0.625	0.500	0.250	0.032
P 387312	3.875	3.125		0.562	0.375	0.187	0.032
P 400300	4.000	3.000		0.625	0.500	0.250	0.032
P 400300/2	4.000	3.000		0.375	0.500	0.250	0.032
P 400325/1	4.000	3.250		0.562	0.375	0.187	0.032
P 400325/2	4.000	3.250		0.500	0.375	0.187	0.032
P 400350	4.000	3.500		0.375	0.250	0.125	0.015
P 412337	4.125	3.375		0.562	0.375	0.187	0.032
P 412350	4.125	3.500		0.375	0.312	0.156	0.015
P 425325	4.250	3.250		0.750	0.500	0.250	0.032
P 425350/1	4.250	3.500		0.562	0.375	0.187	0.032
P 450350/1	4.500	3.500		0.562	0.500	0.250	0.032
P 450350/2	4.500	3.500		0.750	0.500	0.250	0.032
P 450350/3	4.500	3.500		0.375	0.500	0.250	0.032
P 450375	4.500	3.750		0.500	0.375	0.187	0.032
P 450375/1	4.500	3.750		0.410	0.375	0.187	0.032
P 450400	4.500	4.000		0.375	0.250	0.125	0.015
P 462362	4.625	3.625		0.750	0.500	0.250	0.032
P 462362/1	4.625	3.625		0.500	0.500	0.250	0.032
P 475375/1	4.750	3.750		0.812	0.500	0.250	0.032
P 475375/2	4.750	3.750		0.750	0.500	0.250	0.032
P 475425	4.750	4.250		0.375	0.250	0.125	0.015
P 487400	4.875	4.000		0.656	0.437	0.187	0.032
P 487437	4.875	4.375		0.375	0.250	0.125	0.032
P 500400	5.000	4.000		0.750	0.500	0.250	0.032
P 500425	5.000	4.250		0.562	0.375	0.187	0.032
P 525400	5.250	4.000		0.500	0.625	0.250	0.046
P 525425	5.250	4.250		0.750	0.500	0.250	0.032
P 537437	5.375	4.375		0.750	0.500	0.250	0.032
P 550450	5.500	4.500		0.750	0.500	0.250	0.032
P 550500	5.500	5.000		0.375	0.250	0.125	0.015
P 575475	5.750	4.750		0.750	0.500	0.250	0.032
P 600500	6.000	5.000		0.750	0.500	0.250	0.032
P 600537	6.000	5.375		0.375	0.312	0.156	0.015
P 625525/1	6.250	5.250		0.531	0.500	0.250	0.032
P 625525/3	6.250	5.250		0.875	0.500	0.250	0.032
P 625550	6.250	5.500		0.687	0.375	0.187	0.032
P 650550	6.500	5.500		0.750	0.500	0.250	0.032
P 675575	6.750	5.750		0.750	0.500	0.250	0.032
P 700575	7.000	5.750		0.937	0.625	0.250	0.046
P 700600	7.000	6.000		0.750	0.500	0.250	0.032
P 700625	7.000	6.250		0.562	0.375	0.156	0.015
P 775650	7.750	6.500		1.000	0.625	0.250	0.046
P 800700	8.000	7.000		0.875	0.500	0.250	0.032

Single Acting Rod Seal Imperial
P

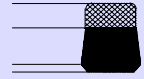
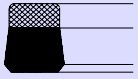

Nominal Dimensions & Machining Tolerances

Claron Part Number	Js11	f8	H9	+0.025 +0.015	Nominal	Min	Max
	ØD ₁	Ød ₁	ØG	L ₁	S	C	R ₁
P 850725	8.500	7.250		1.000	0.625	0.250	0.046
P 950837	9.500	8.375		0.750	0.562	0.250	0.046