

Double Acting Piston Seal Metric Imperial

DPE

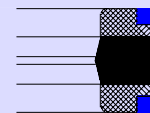
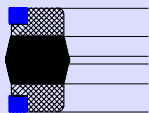

Design

Designed for use on split pistons, the seal is a precision moulded rubber element with rubberised fabric reinforcements. Style DPE is fitted with Polyacetal anti-extrusion rings on the O.D. to allow larger machining clearances between the piston head and cylinder bore, and to permit higher working pressures. The seal is designed with sufficient radial sectional interference that on complete assembly low pressure sealing is effected. The supporting rubberised fabric has the capability of retaining the sealing media thus assisting in reducing friction and wear. Style DPE has proven to be effective over a wide range of applications.

Operating Conditions

Maximum Pressure	
Max Speed	Temp. Range
m/s	-30°C to 100°C
0.50	250 Bar
0.15	400 Bar

These range parameters are Maximum simultaneous conditions.

Optimum service conditions are affected by temperature, speed, pressure, surface finish and extrusion gaps.

Refer to Appendix 1 for further information.
Maximum Diametral Clearance F

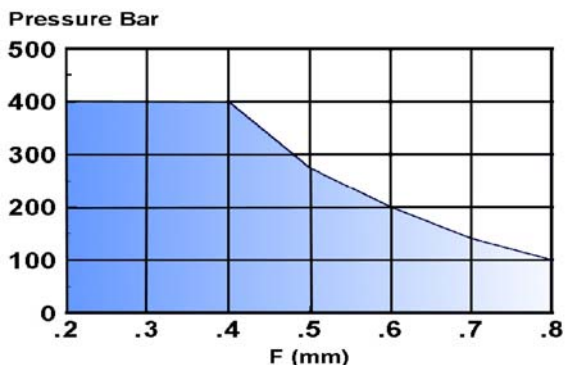

Continuous operating temperature for various fluids

NBR Rubber		
DIN	Hydraulic Fluid Description	°C
H	Mineral oil without additives	100
H-L	Mineral Fluid with anti corrosion and anti ageing additives	100
H-LP	Mineral oil as HL plus additives reducing wear, raising load	100
H-LPD	Mineral oil as H-LP but with detergents and dispersants	100
H-V	Mineral oil as H-LP plus improved viscosity temp.	100
HFA E	Emulsions of mineral oil in water. Water content 80-95%	55
HFA S	Synthetic oil in water. Water content 80-95%	55
HFB	Emulsions of water in mineral oil. Water content 40%	60
HFC	Aqueous polymer solutions. Water content 35%	60
HFD R	Phosphoric acid ester based	NS
HFD S	Chlorinated hydrocarbon based	NS
HFD T	Mixtures of HFD R and HFD S	NS
HEPG	Polyglycol based	NS
HETG	Vegetable Oil based	60
HEES	Fully synthetic ester based	NS

Note: Clearance gap F is the maximum permissible. i.e. gap completely on one side, in the temperature range of -30°C to 100°C
 The use of a suitably selected Claron bearing ring will effectively reduce the clearance gap F max. to a value closer to F/2 thus increasing the pressure capability of the seal.

Housing

For surface finish and recommended lead in chamfers refer to the illustration below. For housing dimensions and machining tolerances refer to the catalogue page of selected seal. Refer to Appendix 4 for value of tolerance symbols.

Fitting

For the seal to function correctly, it is important that care be taken in fitting the seal within its housing.
 For a detailed checklist, refer to Appendix 3.

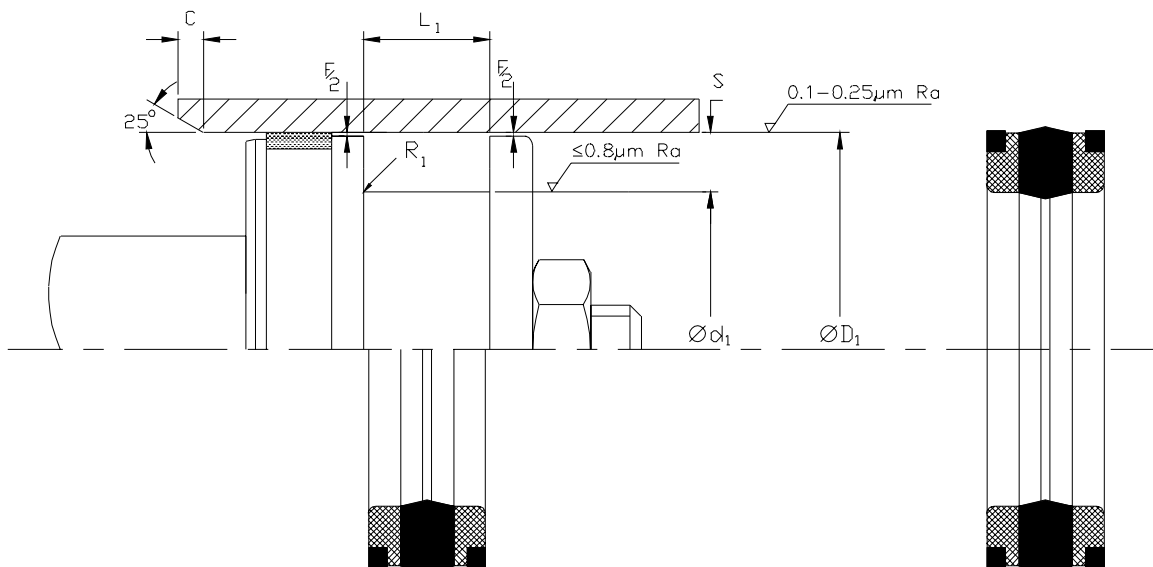

ClaronPolyseal®
Double Acting Piston Seal

Metric

DPE

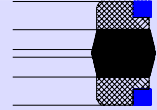
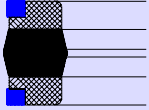

Nominal Dimensions & Machining Tolerances

Claron Part Number	H11	js11	+0.63 +0.38	Nominal	Minimum	Maximum
	ØD ₁	Ød ₁	L ₁	S	C	R ₁
DPE 098047	25	12	12	6.5	2.5	0.4
DPE 118066	30	17	15	6.5	2.5	0.4
DPE 157094	40	24	18	8.0	4.0	0.4
DPE 177114	45	29	18	8.0	4.0	0.4
DPE 188125	48	32	18	8.0	4.0	0.4
DPE 196133	50	34	18	8.0	4.0	0.4
DPE 216153/1	55	39	18	8.0	4.0	0.4
DPE 236173/1	60	44	18	8.0	4.0	0.4
DPE 248185	63	47	19	8.0	4.0	0.4
DPE 255196	65	50	18	7.5	4.0	0.6
DPE 275196	70	50	22	10.0	5.0	0.8
DPE 295216	75	55	22	10.0	5.0	0.8
DPE 314236	80	60	22	10.0	5.0	0.8
DPE 334255	85	65	22	10.0	5.0	0.8
DPE 354275	90	70	22	10.0	5.0	0.8
DPE 393295	100	75	22	12.5	6.5	1.2
DPE 393314	100	80	25	10.0	5.0	0.8
DPE 413314	105	80	22	12.5	6.5	1.2
DPE 433334/1	110	85	22	12.5	6.5	1.2
DPE 452354	115	90	22	12.5	6.5	1.2
DPE 472374	120	95	22	12.5	6.5	1.2
DPE 492393	125	100	25	12.5	6.5	1.2
DPE 531433	135	110	25	12.5	6.5	1.2
DPE 551472	140	120	25	10.0	5.0	0.8
DPE 570472	145	120	25	10.0	5.0	0.8
DPE570492	145	125	25	10.0	5.0	0.8
DPE 590492	150	125	25	12.5	6.5	1.2
DPE 629511	160	130	25	15.0	7.5	1.2

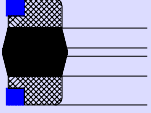

Claron[®]Polyseal[®]
Double Acting Piston Seal

Imperial

DPE

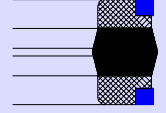

Nominal Dimensions & Machining Tolerances

Claron Part Number	H11 ØD ₁	js11 Ød ₁	+0.025" +0.015" L ₁	Nominal S	Minimum C	Maximum R ₁
DPE 100062	1.000	0.625	0.468	0.187	0.093	0.008
DPE 112062	1.125	0.625	0.500	0.250	0.125	0.015
DPE 125075	1.250	0.750	0.625	0.250	0.125	0.015
DPE 150100	1.500	1.000	0.625	0.250	0.125	0.015
DPE 162112	1.625	1.125	0.625	0.250	0.125	0.015
DPE 175112	1.750	1.125	0.750	0.312	0.156	0.025
DPE 200137	2.000	1.375	0.750	0.312	0.156	0.025
DPE 212150	2.125	1.500	0.750	0.312	0.156	0.025
DPE 225162	2.250	1.625	0.750	0.312	0.156	0.025
DPE 237175	2.375	1.750	0.750	0.312	0.156	0.025
DPE 250187	2.500	1.875	0.750	0.312	0.156	0.025
DPE 250187/1	2.500	1.875	0.937	0.312	0.156	0.025
DPE 262200	2.625	2.000	0.750	0.312	0.156	0.025
DPE 275200	2.750	2.000	0.937	0.375	0.187	0.031
DPE 300225	3.000	2.250	0.937	0.375	0.187	0.031
DPE 300225/1	3.000	2.250	1.125	0.375	0.187	0.031
DPE 312237	3.125	2.375	0.937	0.375	0.187	0.031
DPE 325250	3.250	2.500	0.937	0.375	0.187	0.031
DPE 350275	3.500	2.750	0.937	0.375	0.187	0.031
DPE 375300	3.750	3.000	0.937	0.375	0.187	0.031
DPE 387312	3.875	3.125	0.937	0.375	0.187	0.031
DPE 400325	4.000	3.250	0.937	0.375	0.187	0.031
DPE 425350	4.250	3.500	0.937	0.375	0.187	0.031
DPE 450350	4.500	3.500	1.250	0.500	0.218	0.046
DPE 450350/1	4.500	3.500	1.500	0.500	0.218	0.046
DPE 475375	4.750	3.750	1.250	0.500	0.218	0.046
DPE 500400	5.000	4.000	1.250	0.500	0.218	0.046
DPE 525425	5.250	4.250	1.250	0.500	0.218	0.046
DPE 550450	5.500	4.500	1.250	0.500	0.218	0.046
DPE 550450/2	5.500	4.500	1.500	0.500	0.218	0.046
DPE 575475	5.750	4.750	1.250	0.500	0.218	0.046
DPE 600500	6.000	5.000	1.250	0.500	0.218	0.046
DPE 650550	6.500	5.500	1.250	0.500	0.218	0.046
DPE 700600	7.000	6.000	1.250	0.500	0.218	0.046
DPE 800700	8.000	7.000	1.250	0.500	0.218	0.046